



Epiroc, SmartROC T25 R

Joakim Zander





SmartROC T25 R

SmartROC styrsystem

- Beprovade komponenter
- Hög igenkänningsfaktor
- Lättanvänd 10-tums pekskärm
- Optimerad bränsleförbrukning
- Exakt borrstyrning för bästa borrarprestanda och livslängd

Exceptionell täckarea

- 45/45 eller 90/90 graders svängradie
- 28 m² (45/45) eller 45 m² (90/90) täckarea
- Lång räckvidd
- 5,5 eller 6,1 meters bomsystem
- 360° matarsväng
- Bomgeometrin möjliggör borrning i direkt anslutning till maskinen

Applikationsoptimering

- Flexibelt bomsystem (olika arbetsområden)
- Kompakt transportläge
- Gummilarv/Ställarv
- Tre olika matarlängder
- Luftspolning, vattenspolning, vattendimning

Goda terrängegenskaper

- Låg tyngdpunkt
- Utökad bredd mellan larvband
- Stor rörlighet i bommen
- Kraftigt stödben av labbtyp

United. Inspired.

Preliminära riggspecifikationer

Täckareor

Horisontell räckvidd (mm) – 45/45

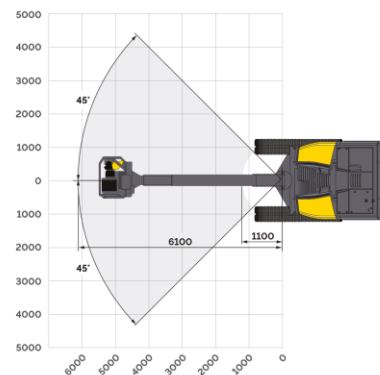

Horisontell räckvidd (mm) – 90/90

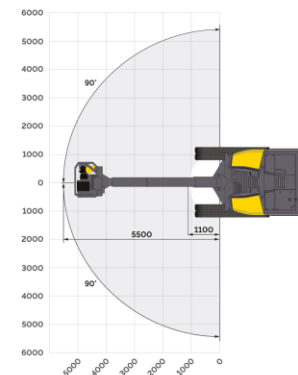

Horisontell borrning (mm) – 45/45

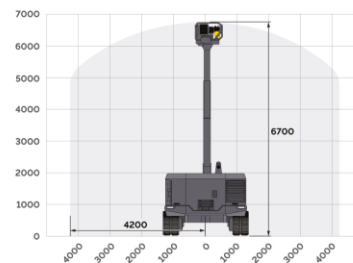

Horisontell borrning (mm) – 90/90

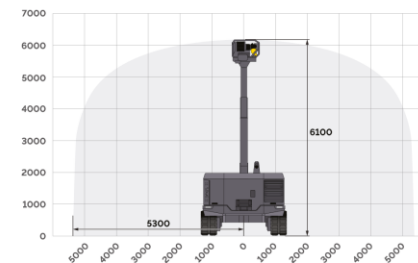

Matarhöjd

8 ft matare (2,4 m)	4 000 mm
10 ft matare (3 m)	4 600 mm
14 ft matare (4,3 m)	5 800 mm

Transportmått

Höjd (H)	2 880 mm
Längd (L)	6 350 mm
Bredd (B)	2 445 mm
Vikt	11 400 kg

Bränsleförbrukning

Snittvärde enligt testcykel 40% borrning, 100% spilluft	13,4 l/timme
---	--------------

Volym

Hydrauloljetank	97 l
Hydraulsystem, totalt	150 l
Kompressorolja	25 l
Dieselmotorolja	16 L
Dieselmotor, bränsletank	190 l
Smörjtank (ECL)	5 l
DEF-tank	25 l

Hålområde (rekommenderat)

Matartyp	Metrisk	Amerikansk	Gångor	Rod Adding System (RAS)	
				2 borrstål	2+ borrstål
Med 8 ft matare				3,9 m	
Med 10 ft matare	Ø 38-64 mm	Ø 1,5"-2,5"	SR32, R32, TC35, T35	5,1 m	15 m ²
Med 14 ft matare				7,6 m	

Hydraulisk bergbormaskin

Bergbormaskin	Borttyp	Rotationsmotor
COP SC14	Vikbom	160 cc
		200 cc

SmartROC T25



Matare

Tre olika matarlängder + 360 grader matarsväng



Matare

Borrfot – två varianter + kompakt borrstöd



Matare

Bullerdämpare



Bom

2 x bomval 45/45 (6,1 m) eller 90/90 (5,2 m)



Bom

Kompakt transportläge med bom på taket



Vattendimustrustning

Option (50l eller 150l)



Chassi / Bärare

Stödben



Bandramar

Gummlarv med hög hastighet och lågt marktryck



Bandramar

Traditionell stållarv



SmartROC styrsystem

SmartROC plattform

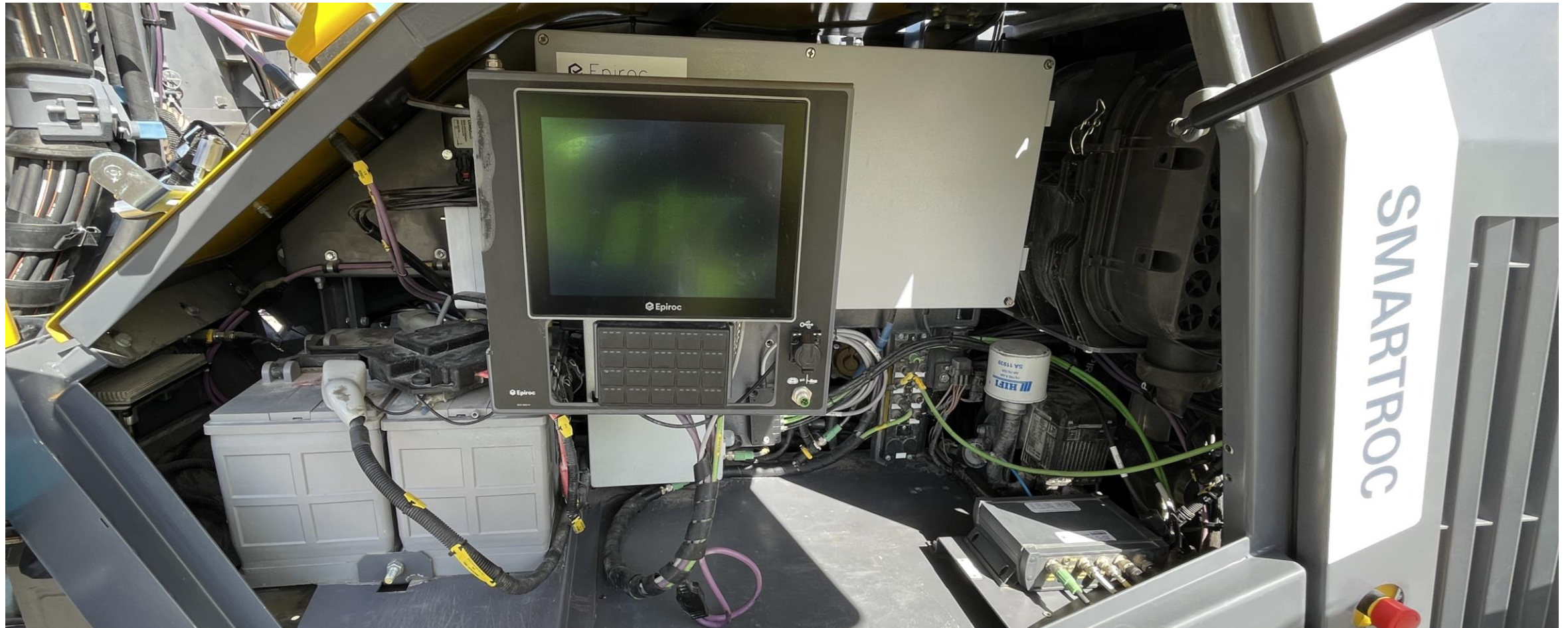



Nullutslipps produksjons maskiner



EPIROC - Komplett på nullutslipp underjordsmaskiner i 2025



EPIROC tilbyr idag følgende nullutslippsmaskiner

Boring

1&2 boms tunnel rigg, produksjonsrigg og bolterigg
Fast batteri for fremdrift, lader på stuff

Utlasting

Hjullaster ST14 (40t) og dumper MT42
Battery swap for kontinuerlig drift

Rockvolt – Ladere & infra – Mobilaris - Konverteringer

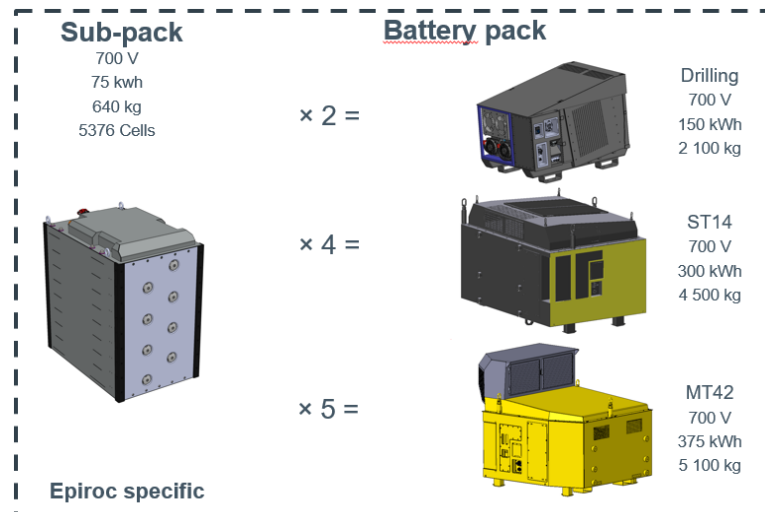

EPIROC - Komplett på nullutslipp underjordsmaskiner i 2025



Nullutslippsmaskiner under utvikling

Boring

3 boms tunnelrigg <52t samt komplettering av små og medium serier
Fast batteri for fremdrift, lader på stoff

Utlasting

Hjullaster ST18 <50t og dumper MT65 (65t)
Battery swap for kontinuerlig drift

Jobbes også med ulike varianter av pantograph for dumpere med lang og eller bratt kjøring

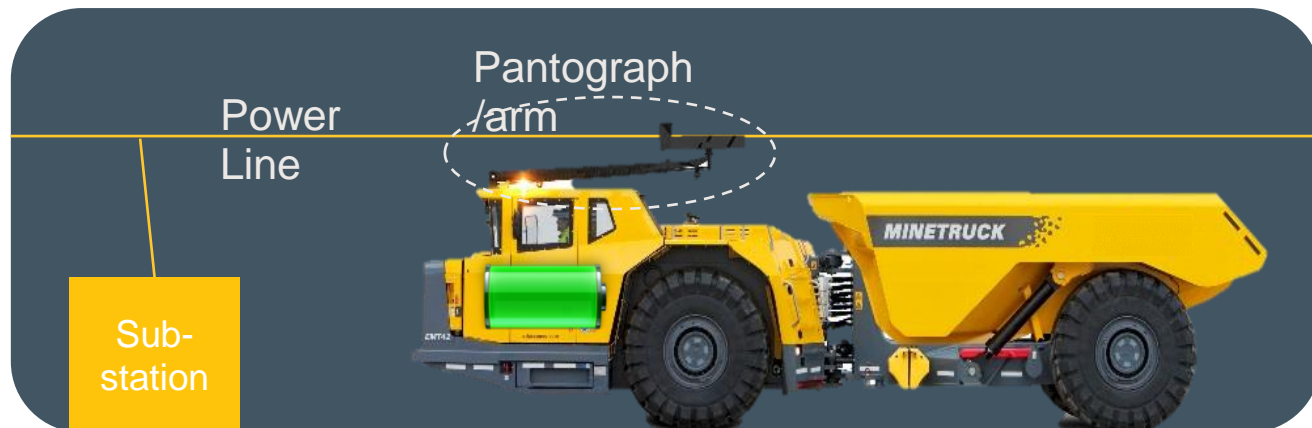

Truck



Battery swap

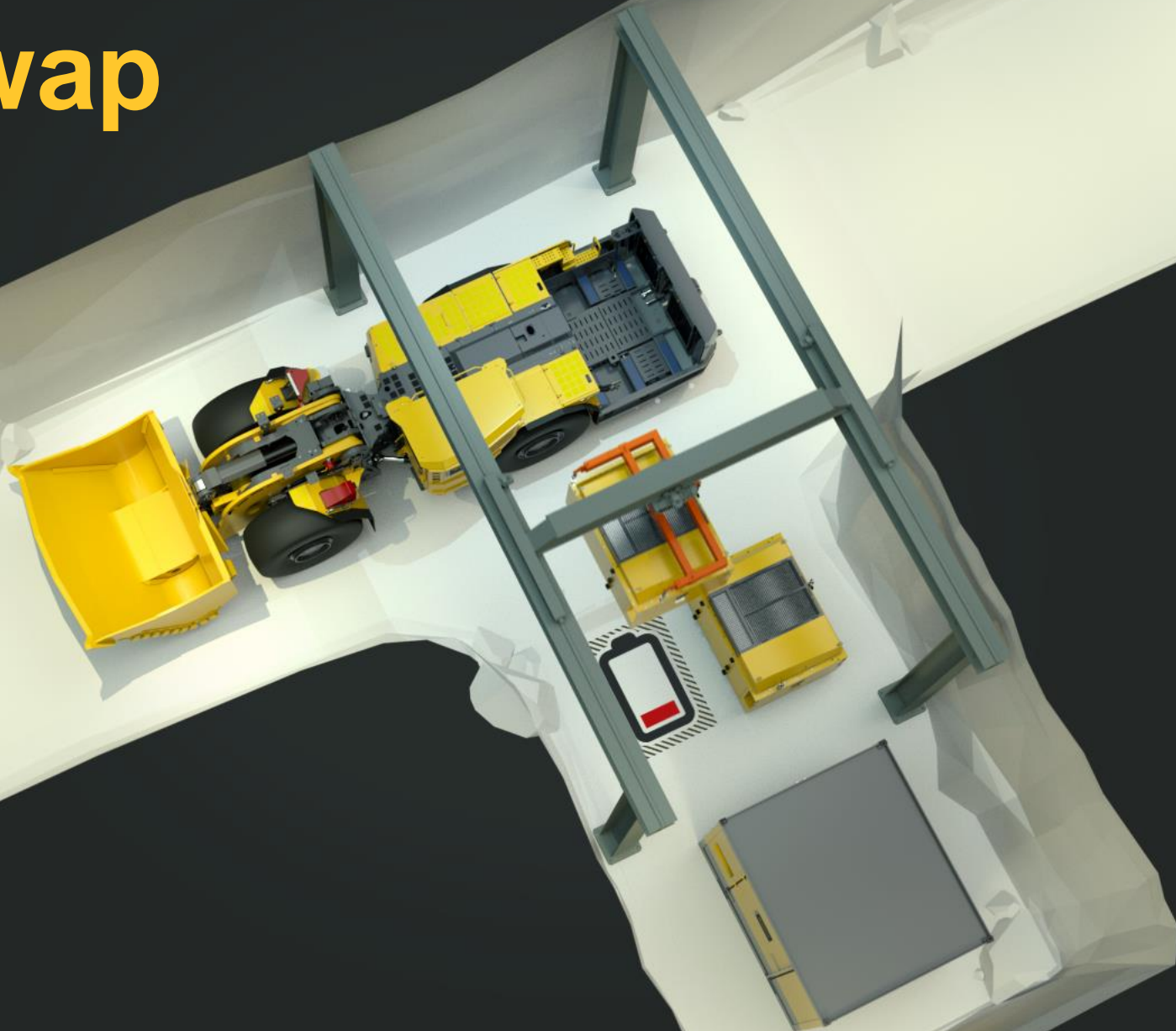

Epiroc, Vei og Anlegg

Stand D01-21



United. Inspired.

Performance unites us, innovation inspires us,
and commitment drives us to keep moving forward.

Count on Epiroc to deliver the solutions you need
to succeed today and the technology to lead tomorrow.

[epiroc.com](https://www.epiroc.com)



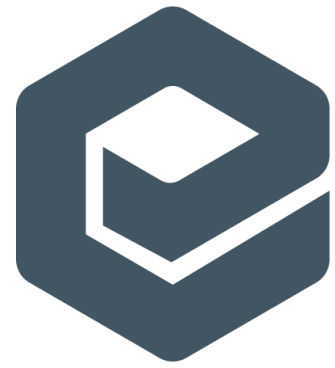

Epiroc